

1026-75

INDUCED POLARIZATION TRAVERSE
SECTIONAL DATA SHEET
of
THE BELL AREA
YAVAPAI COUNTY, ARIZONA
for
THE SUPERIOR OIL COMPANY

LINE NO.
12S
SPREAD(S)
1
BEARING
E-W

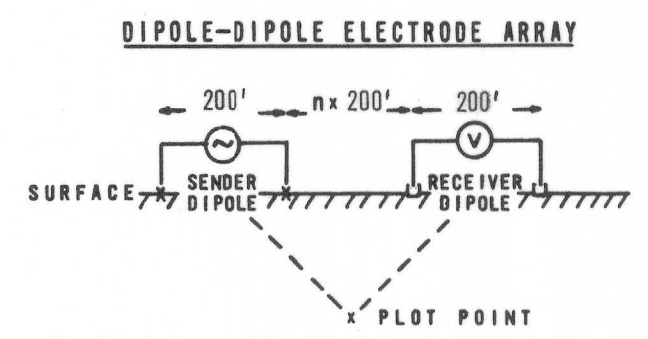
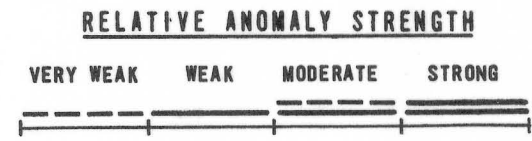

DATE
JULY 1975

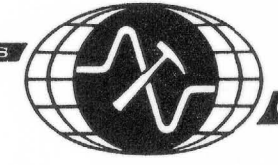
HEINRICHS  GEOEXPLORATION COMPANY
806 W. GRANT ROAD, POST OFFICE BOX 5964, TUCSON, ARIZ., 85703, PHONE: (602)623-0578