

1040-75

INDUCED POLARIZATION TRAVERSE
SECTIONAL DATA SHEET
of
BINGHAMPTON AREA
YAVAPAI COUNTY, ARIZONA
for
AMERICAN SELCO, INC.

LINE NO.
7N
SPREAD(S)
1
BEARING
N 80° W

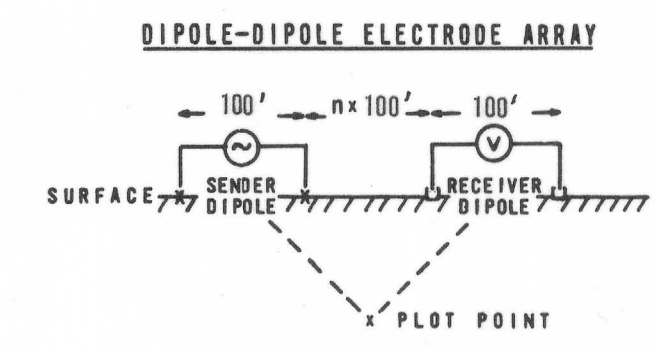
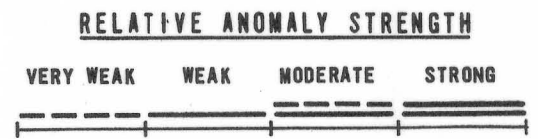

DATE
AUGUST 1975

HEINRICHS GEOEXPLORATION COMPANY

806 W. GRANT ROAD, POST OFFICE BOX 5964, TUCSON, ARIZ., 85703, PHONE: (602)623-0578