

914-74

INDUCED POLARIZATION TRAVERSE
SECTIONAL DATA SHEET
of
RIBBON GROUP - MARICOPA COUNTY, ARIZONA
for
CUOX MINING, INC.

LINE NO. 2
SPREAD(S) 1
BEARING N 45° E

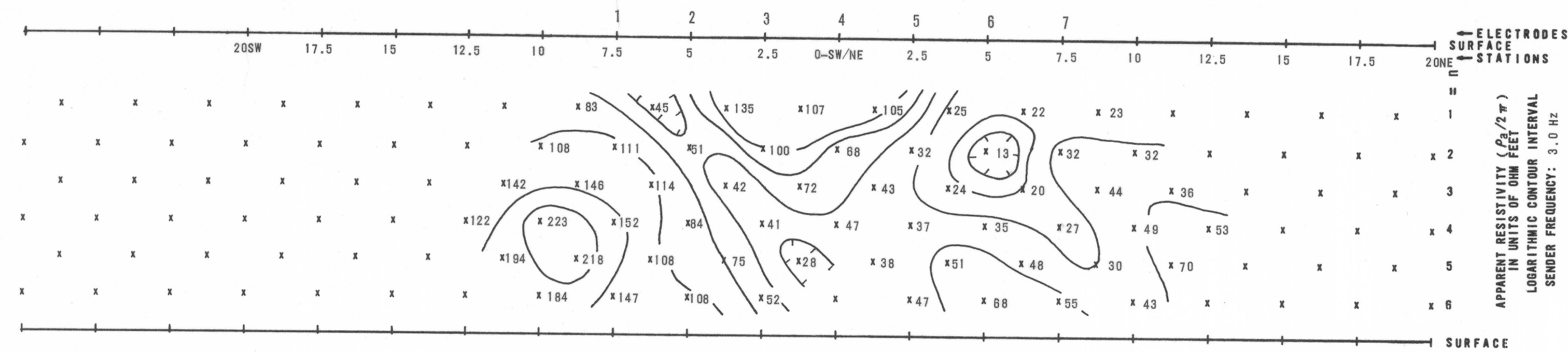

APPARENT RESISTIVITY ($P_a/2\pi$)
IN UNITS OF OHM FEET
LOGARITHMIC CONTOUR INTERVAL
SENDER FREQUENCY: 3.0 HZ

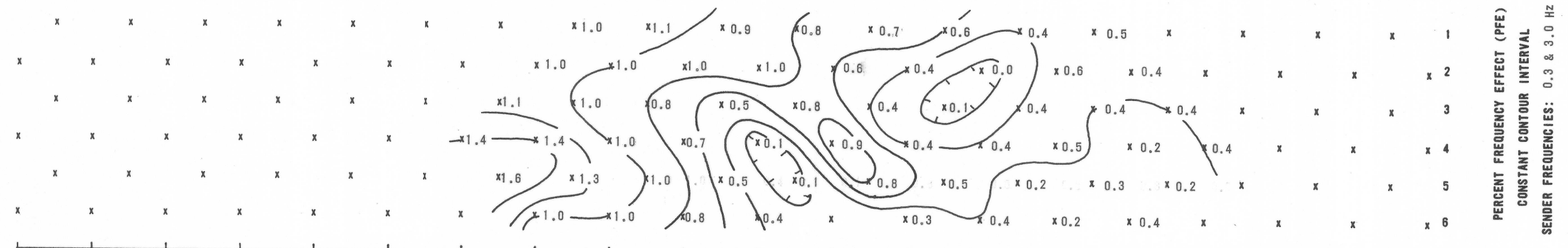
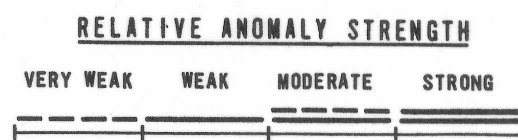

PERCENT FREQUENCY EFFECT (PFE)
CONSTANT CONTOUR INTERVAL
SENDER FREQUENCIES: 0.3 & 3.0 HZ

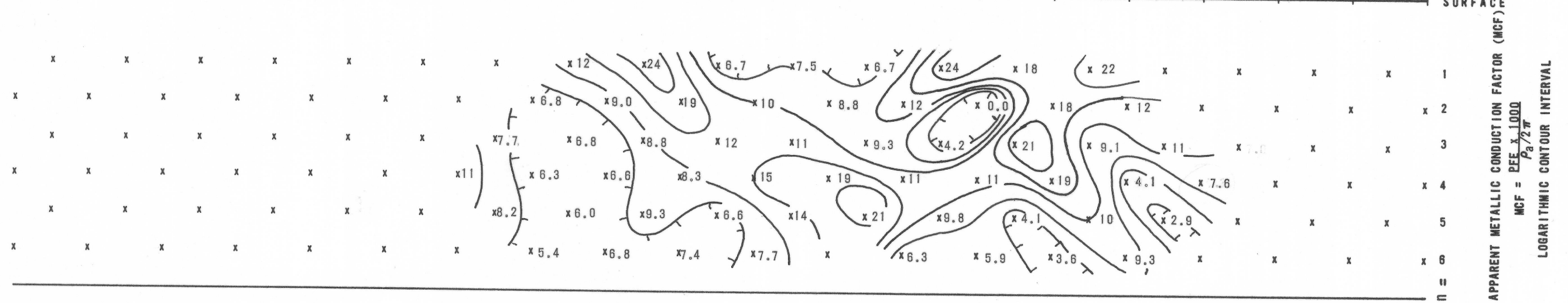
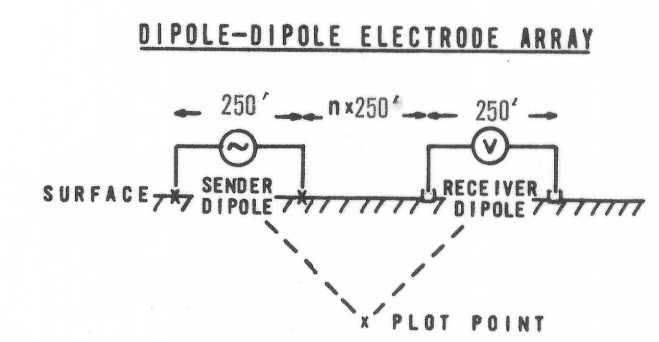

APPARENT METALLIC CONDUCTION FACTOR (MCF)
 $MCF = \frac{PFE \times 1000}{P_a/2\pi}$
LOGARITHMIC CONTOUR INTERVAL

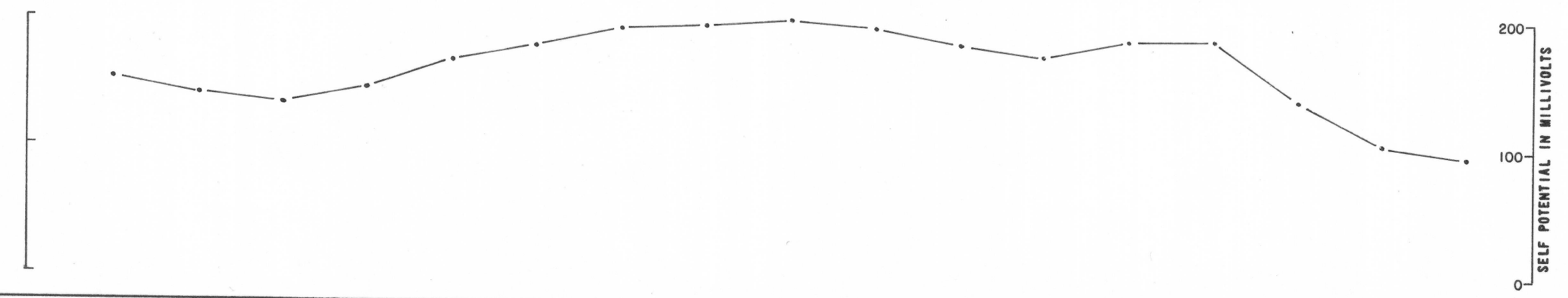

DATE
MARCH 1974

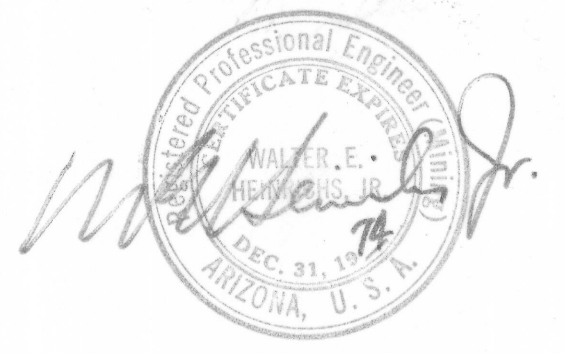

HEINRICHS GEOEXPLORATION COMPANY
806 W. GRANT ROAD, POST OFFICE BOX 5964, TUCSON, ARIZ., 85703, PHONE: (602)623-0578